

GDO-12 HiRO

High Rolling Door Opener

Instruction Manual

(Instruction d'Installation)



Conforms to:
ANSI/CAN/UL325
Tested to comply
with Part 15 of the
FCC Rules

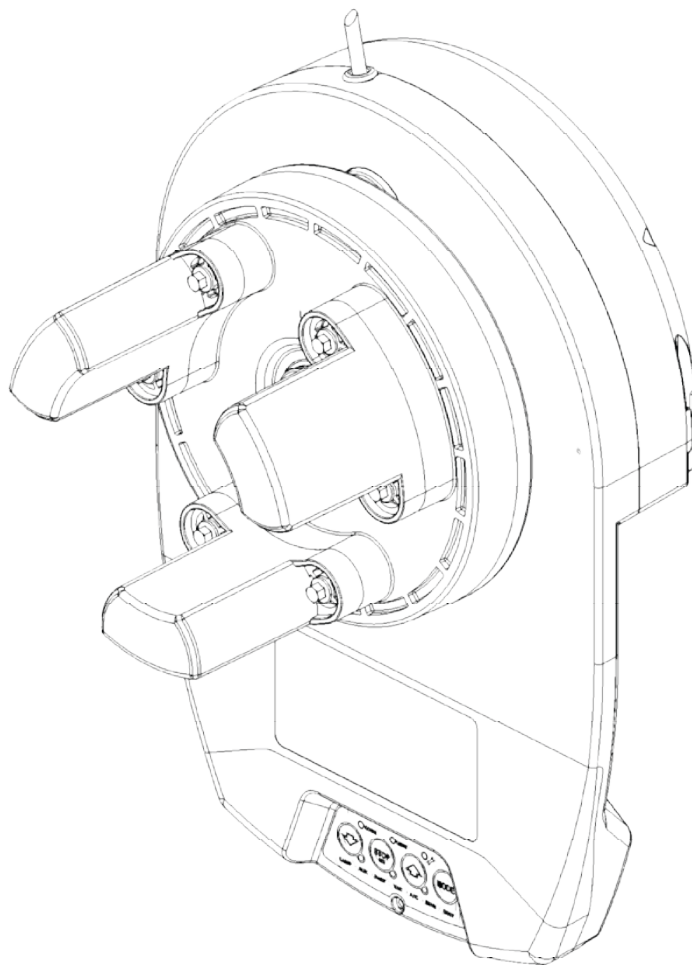

MODEL: GDO-12V1AM

**FOR USE WITH EITHER RESIDENTIAL OR
LIGHT-DUTY COMMERCIAL DOORS**

Doc # 160492_01
Part # 100629
Released 20/12/22

automatic
TECHNOLOGY

GDO-12 HiRO

High Roll Up Garage Door Opener

Contents

1. System Specifications	3	6.6 Auto-Close	14
2. Safety Information	4	6.7 Safety Testing & Accessories	15
3. Sécurité	5	6.7.1 Testing the Close Cycle	15
4. Kit Contents	6	6.7.2 Testing the Open Cycle	15
5. Operator Safety & Security	7	6.7.3 Installation of Premium Wall Control	15
5.1 Your Door CAN NOT be used by the opener when:	7	6.8 Coding Transmitters	16
5.2 Your Door CAN be used when:	7	6.8.1 Remote Control Transmitter Button to Operate Door	17
5.3 To Disengage the Opener:	7	6.8.2 Erasing Programmed Codes	17
5.4 To Re-Engage the Opener:	7	6.8.3 Selecting The Function To Be Coded	17
6. Installation Instructions	8	6.8.4 Installing a wall button control	17
6.1 Pre-Installation Requirements	9	6.9 Attach Warning Labels	18
6.1.1 Door Operation	9	7. Operation Instructions	19
6.1.2 Unsuitable Door Types	9	7.1 How to Use Your Operator	20
6.1.3 Position	9	7.1.1 To Operate the opener:	20
6.1.4 Power Supply	9	7.1.2 Replacing the Battery: 3V Lithium Battery CR2032.	20
6.1.5 Sideroom	9	7.2 User Operating Controls	21
6.1.6 Forks	9	7.3 Door Status Indicators	21
6.2 Door Preparation	10	7.4 Disposal of Batteries	22
6.2.1 Preparation	10	8. User Maintenance Instruction	23
6.2.2 Pinning the Door to the drum:	10	8.1 Door Maintenance	23
6.2.3 Door prop preparation	10	8.2 If You Need a Service Call	23
6.3 Fitting the Opener	11	9. Troubleshooting	24
6.4 Safety Beam Installation	12	10. Appendix	25
6.4.1 Safety Infra-Red Beam Kit (P/N 62047)	12	A - Adjustment Mode Parameters	25
6.4.2 Assembling the Mounting Bracket	12	B - Setting the PET Mode position	26
6.4.3 Aligning the Transmitter and receiver	12	C - LED Status	26
6.5 Setting Speed and Limits	13	D - Setting Limits via Transmitter	27
6.5.1 Set the Limit Positions and adjust drive speed:	13	E - Additional Remote Control Functions	28
6.5.2 Clearing the Door Limit Positions	14		
6.5.3 Re-profiling the Door	14		



1. System Specifications

Technical Specifications	GDO-12V1AM
Input voltage	120V
Frequency	60Hz
Current (max):	2A
Maximum pull force	400N
Type of door: Max curtain weight: Maximum door area (wind-lock): Maximum door area: Door must be well balanced and able to be operated by hand, as per warranty conditions and standard UL 325	Rolling Sheet Door 352 lbs 236ft ² * 301ft ²
Minimum sideroom	3 ³ / ₄ "
Receiver type	Multi-frequency UHF
Receiver code storage capacity	64 x 4-button Transmitters
Number of code combinations	Over 100 billion random codes
Transmitter battery	CR2032 (3 Volts)
Courtesy light	LED (Light Emitting Diodes)
Battery backup	Battery compatible, (requires optional Battery Backup kit)
Network connectivity	Network compatible, (requires optional Smart Phone Control Kit)
Type of entrapment protection	Photo Electric Beam

*: Windy conditions can activate the obstruction feature of the opener.



2. Safety Information



WARNING! It is vital for the safety of persons to follow all instructions. Failure to comply with the installation instructions and the safety warnings may result in serious personal injury and/or property and remote control opener damage. Please save these instructions for future reference.

- This operator should be installed in accordance with relevant US and Canada Standards.
- **To reduce the risk of injury to persons – Use this operator only with a rolling door.** The drive must not be used with a door incorporating a wicket door, unless the drive cannot be operated with the wicket door open.
- All warning signs and placards must be installed where visible in the area of the door.
- This operator is a plug in domestic appliance and is designed for indoor use only. It must be installed in a dry position that is protected from the weather.
- Door must have Safety Beams fitted.
- Activate the operator only when the garage door is in full view, free of obstructions and with the operator properly adjusted.
- The network device allows for operation of the door when not in line-of-sight of the door and operator. Therefore the door may operate unexpectedly, therefore do not allow anything to stay in or near the path of the door.
- Watch the moving door and keep people away until the door is completely opened or closed.



ELECTROCUTION: To reduce the risk of electric shock, this equipment has a grounding type plug that has a third (grounding) pin. This plug will only fit into a grounding type outlet. If the plug does not fit into the outlet, contact a qualified electrician to install the proper outlet. Do not change the plug in any way. This operator is not equipped for permanent wiring. Contact a qualified electrician to install a suitable receptacle if one is not available.

- Installation and wiring must be in compliance with your local building and electrical codes.
- If the power cord is damaged, it must be replaced by the manufacturer, its service agent or a similarly qualified person in order to avoid a hazard.
- Connect the power cord only to properly earthed mains. If an extension lead must be used, make sure it is a 3-core lead and approved to 7 amp capacity.
- This unit is not user serviceable. Unplug the power cord before removing the cover. Ensure that the power cord is attached clear of all moving parts. Ignoring these instructions can cause electric shock.

Please read these important safety rules

These safety alert symbols indicate a personal safety or property damage instruction exists. **READ THESE INSTRUCTIONS CAREFULLY.**

This automatic garage door operator is designed and tested to offer safe service provided it is installed and operated in strict accordance with the following safety rules. Failure to comply with the installation instructions and the safety warnings may result in death, serious personal injury and/or property damage.



CAUTION:

- If your garage has no pedestrian entrance door, an emergency access device should be installed. This accessory allows manual operation of the garage door from outside in case of power failure.
- Keep the garage door balanced. Sticking or binding doors must be repaired. Garage doors, door springs, brackets and their hardware are under extreme tension and can cause serious personal injury. Do not attempt any garage door adjustment. Do not use if repair or adjustment is needed. Call for professional garage door service.
- Position the Garage Door Operator so that the power plug is accessible when inserted into the power outlet.
- Install the wall transmitter in a location where the garage door is visible, but out of the reach of children at a height of at least 5 feet (1.53m).
- To avoid serious personal injury from entanglement, remove all unnecessary ropes or chains and disable any equipment such as locks which are not needed for powered operation.
- Do not wear rings, watches or loose clothing while installing or servicing a garage door operator.
- Ensure ladder is the correct type for the job and is on flat ground. We recommend the user has 3 points of contact while on ladder.
- Activate the operator only when the garage door is in full view, free of obstructions and with the operator properly adjusted.
- The operator is not intended for use by young children or infirm persons without supervision.
- Keep transmitters away from children.
- Do not allow children to play with door controls.

3. Sécurité



AVERTISSEMENT ! pour la sécurité des usagers, il est essentiel de suivre toutes les instructions. Le non-respect des instructions d'installation et des avertissements de sécurité peut causer de graves blessures et/ou endommager l'appareil et la télécommande. Conservez ces instructions en lieu sûr.

- Cet appareil doit être installé conformément aux normes US et canadiennes en vigueur.
- Pour réduire les risques d'accident, n'utiliser cet appareil qu'avec une porte de garage enroulable. Ce moteur ne doit pas être utilisé avec une porte de garage avec portillon, à moins que le moteur ne puisse fonctionner quand le portillon est ouvert.
- Toutes les étiquettes et les panneaux de mise en grade doivent être installés à un endroit visible près de la porte.
- Cet appareil est un accessoire domestique conçu pour être utilisé uniquement à l'intérieur. Il doit être installé au sec et à l'abri des intempéries.
- La porte doit être équipée de faisceaux de sécurité.
- Activez l'appareil uniquement lorsque la porte du garage est à la vue, exempte d'obstacles et avec l'appareil bien réglé.
- La télécommande radio permet d'actionner la porte lorsque l'utilisateur est hors de la ligne de vue de la porte et de l'appareil. En conséquence, la porte risque de s'ouvrir ou se fermer inopinément et vous devez éviter de laisser des objets sur sa course ou à proximité.
- Suivez la porte pendant l'ouverture ou la fermeture, et veillez à ce que personne ne se trouve à proximité tant qu'elle n'est pas complètement ouverte ou fermée.



ÉLECTROCUTION : Pour réduire les risques d'électrocution, cet appareil est équipé d'une fiche avec broche de mise à la terre. Cette fiche ne peut être branchée que dans une prise avec mise à la terre. S'il n'est pas possible de la brancher dans la prise, faites poser une prise appropriée par un électricien qualifié. Ne pas modifier la fiche. Ce matériel est pas équipé pour le câblage permanent. En l'absence de réceptacle approprié, contactez un électricien qualifié pour en installer un.

- L'installation et le câblage doivent être effectués conformément aux codes de la construction et de l'électricité en vigueur.
- Si le cordon électrique est abîmé, il doit être remplacé par le fabricant, son SAV agréé ou un technicien qualifié.
- Branchez le cordon électrique uniquement à une prise secteur dûment reliée à la terre. Si vous devez utiliser une rallonge, assurez-vous qu'elle est tripolaire et d'une capacité de 7 ampères.
- Cet appareil n'est pas réparable par l'utilisateur. Avant de retirer le capot, débranchez le cordon électrique. Assurez-vous qu'il ne risque pas d'entrer en contact avec des pièces en mouvement. Le non-respect de ces instructions peut avoir une électrocution pour conséquence.

Lisez attentivement ces règles de sécurité.

Ces pictogrammes indiquent une consigne de sécurité pour les personnes ou les biens. **LISEZ CES INSTRUCTIONS ATTENTIVEMENT.**

Cette commande automatique pour porte de garage est conçue et testée pour fonctionner en toute sécurité. Pour ce faire, elle doit être installée et utilisée dans le strict respect des règles de sécurité suivantes. Le non-respect des instructions d'installation et des avertissements présent un risque de mort, de blessure grave et/ou de préjudice pour les biens.



PRUDENCE :

- Si votre garage ne comporte pas de porte pour piétons, il convient d'installer un dispositif d'accès d'urgence. Cet accessoire permet d'actionner la porte de garage manuellement de l'extérieur en cas de panne d'électricité.
- Veillez à ce que la porte du garage soit bien équilibrée. Si une porte reste « collée » ou qu'elle « accroche », elle doit être réparée. Les portes de garage, les ressorts de porte, les pattes de fixation et les éléments matériels sont soumis à une tension extrême et peuvent blesser gravement. Ne tentez pas de régler la porte de garage par vous-même. Ne l'utilisez pas si une réparation ou un réglage est nécessaire. Faites appel à un technicien spécialisé.
- Positionnez le dispositif de commande de manière à ce que la prise de courant soit accessible lorsqu'elle est branchée.
- Installez l'émetteur mural à un emplacement où la porte du garage est visible, mais hors de portée des enfants, à une hauteur d'au moins 1,50 m.
- Rangez cordes et chaînes pour éviter de vous blesser, et désactivez les serrures et autres équipements qui ne sont pas nécessaires pour une utilisation sous tension.
- Pendant l'installation ou la réparation d'un dispositif de commande de porte de garage, retirez bijoux et montre, et attachez vos vêtements.
- Utilisez un escabeau adéquat et stable. Lorsque l'utilisateur se tient sur un escabeau, il est conseillé de veiller à ce que les points de contact soient au nombre de trois.
- Activez l'appareil uniquement lorsque la porte du garage est à la vue, exempte d'obstacles et avec l'appareil bien réglé.
- L'appareil ne doit pas être utilisé sans supervision par de jeunes enfants ou des personnes infirmes.
- Les émetteurs doivent rester hors de portée des enfants.
- N'autorisez pas les enfants à jouer avec les commandes de porte.

4. Kit Contents

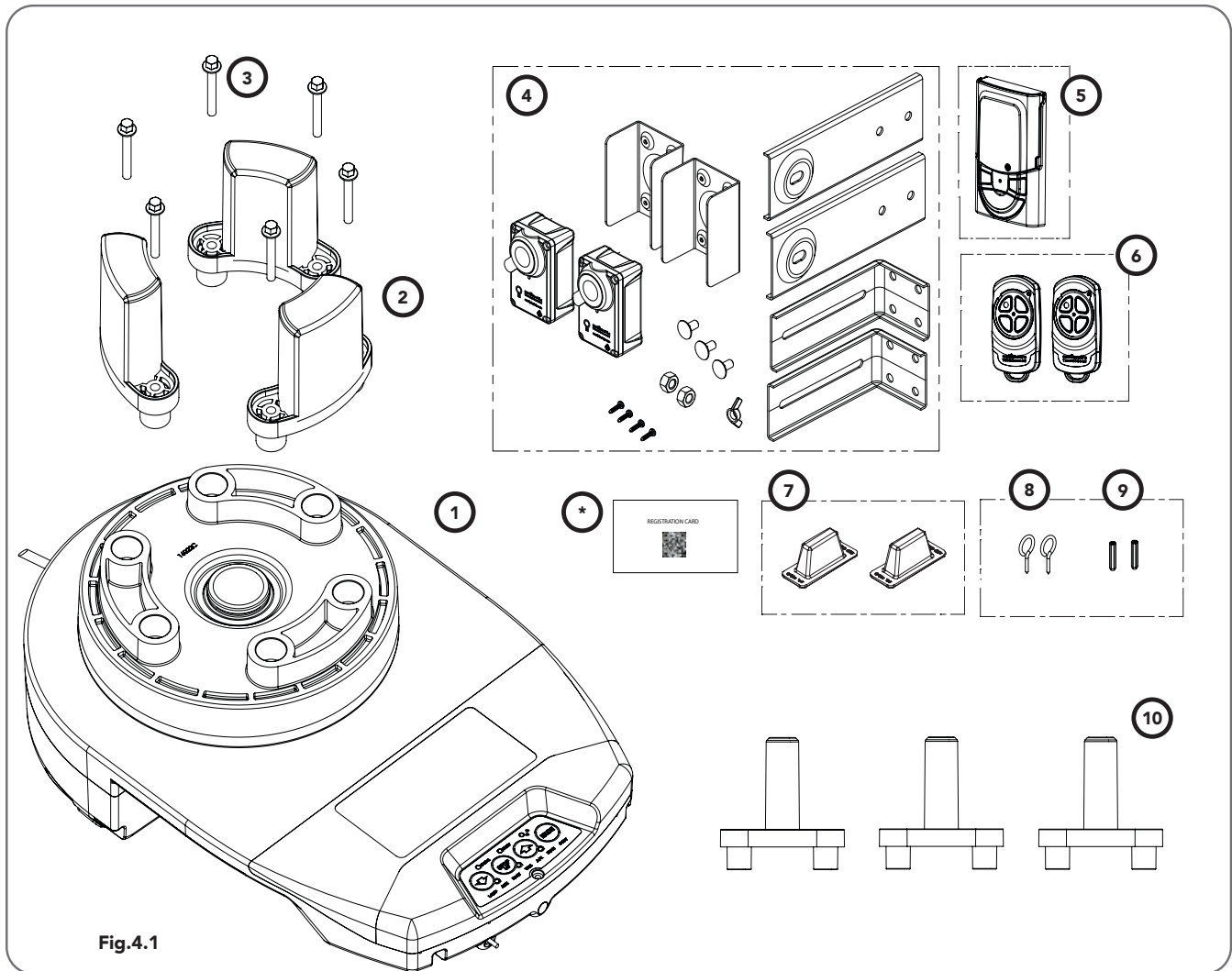

Fig.4.1

4.1 Kit Contents

ITEM	DESCRIPTION	QTY
1	GDO-12 POWER DRIVE UNIT	1
2	JANUS INTERNAL GEAR ADAPTOR	3
3	HEX SERRATION HEAD SCREW M6 X 20	6
4	SAFETY BEAM KIT	1
5	PREMIUM WALL CONTROL	1
6	REMOTE CONTROL TRANSMITTER	2
7	LOCKING BAR COVERS	2
GUIDE PACK VR12		
8	SCREW-EYE	2
9	PLASTIC WALL PLUG 6.9 X 25 (1")	2
ALTERNATIVE FORKS		
10	UNIVERSAL INTERNAL GEAR ADAPTOR	3

6 HIRO Installation Manual GDO-12V1
 * REGISTRATION CARD (Please retain for optional smart phone control kit)

5. Operator Safety & Security

5.1 Your Door CAN NOT be used by the opener when:

- There is a locking device installed.
- There is a power failure.

5.2 Your Door CAN be used when:

- There is an emergency, by disengaging the opener.
- There is a power failure, by disengaging the opener.

5.3 To Disengage the Opener:

tip It is recommended to disengage the door with the door in the closed position.

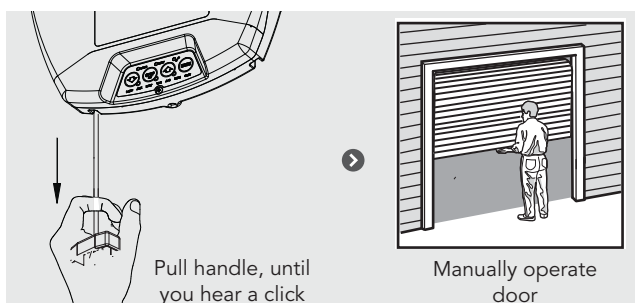

CAUTION: When the opener is manually disengaged, the door is no longer locked. To lock the door manually, re-engage the opener after the door is closed.

ATTENTION: Ne pas utiliser la poignée de chaîne pour ouvrir la porte. Le non-respect de cette consigne peut provoquer des blessures graves.

5.4 To Re-Engage the Opener:

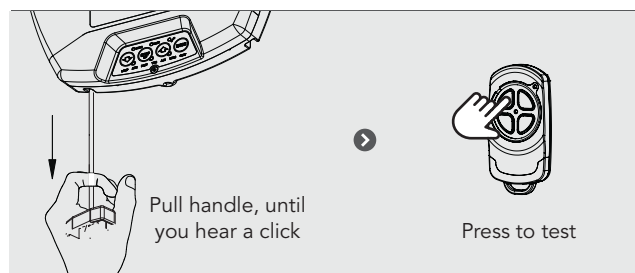

WARNING! Please test the manual release mechanism to ensure that the manual release is easy to operate. No more than 44lb (20kg) of force should be required to disengage the door using the manual release cord. If excessive force is required reset the close limit position (Section 6.7.3 Resetting Door Limits).

AVERTISSEMENT! Tester le dispositif de déclenchement manuel afin de s'assurer que le système se désengage facilement. Ne pas exercer une force de plus de 44lb (20kg) pour désengager la porte en tirant sur le cordon. Si la force à appliquer est excessive, il faudra re-paramétrer le réglage de fin de course.

MANUAL RELEASE

○

WARNING! When operating the manual release (while the door is open) the door may fall rapidly due to weak or broken springs, or due to being improperly balanced.
Do not disengage the operator to manual operation with children/persons or any objects including motor vehicles within the doorway.

IN THE EVENT THE DOOR BECOMES OBSTRUCTED DETACH DOOR FROM OPERATOR AS FOLLOWS:

1. TO DISENGAGE:
PULL HANDLE DOWN & RELEASE

SI LA PORTE EST BLOQUÉE, DÉTACHEZ-LA DU DISPOSITIF DE COMMANDE EN PROCÉDANT COMME SUIT :

1. POUR DÉBLOQUER:
TIRER VERS LE BAS ET RELACHER

2. TO RE-ENGAGE: REPEAT ACTION

2. POUR LA RÉENGAGER:
RÉPÉTER LE MOUVEMENT

PULL HANDLE
↓
TIRER LA POIGNEE

AVERTISSEMENT : Lorsque vous utilisez le déclenchement manuel (alors que la porte est ouverte), la porte peut tomber rapidement si les ressorts sont fatigués ou brisés, ou parce qu'elle est mal équilibrée.
NE PAS désengager l'opérateur en mode manuel lorsque des enfants/personnes, ou des objets tels que des véhicules à moteur, sont dans le passage.

DÉBLOCAGE MANUEL

○

6. Installation Instructions

IMPORTANT INSTALLATION INSTRUCTIONS.

WARNING - To reduce the risk of severe injury or death:

- (1) READ AND FOLLOW ALL INSTALLATION INSTRUCTIONS.
- (2) Install only on a properly operating and balanced sheet door. An improperly balanced door has the potential to inflict severe injury. Have a qualified service person make repairs to cables, spring assemblies, and other hardware before installing the opener.
- (3) Remove all pull ropes and remove or make inoperative, all locks connected to the sheet door before installing opener.
- (4) Where possible, install the door opener 2.14m (7 feet) or more above the floor. For products having an emergency release, mount the emergency release 1.83m (6 feet) above the floor and avoiding contact with vehicles to avoid accidental release.
- (5) Do NOT connect the opener door operator to source of power until instructed to do so.
- (6) Locate the control button:
 - (i) within sight of door,
 - (ii) at a minimum height of 1.53m (5 feet) above floors, landings, steps or any other adjacent walking surface so small children are not able to reach it, and
 - (iii) away from all moving parts of the door.
- (7) Install the Entrapment Warning Label next to the control button in a prominent location.
- (8) After installing the opener, the door must reverse within 2 seconds when it contacts a 1 1/2-inch high object (or a 2 by 4 board laid flat) on the floor.
- (9) For products having a manual release, instruct the end user on the operation of the manual release.
- (10) The following wiring instructions:
 - (i) "This operator is not equipped for permanent wiring. Contact licensed electrician to install a suitable receptacle if one is not available." and;
 - (ii) "TO REDUCE THE RISK OF ELECTRIC SHOCK, THIS EQUIPMENT HAS A GROUNDING TYPE PLUG THAT HAS A THIRD (GROUNDING) PIN. THIS PLUG WILL ONLY FIT INTO A GROUNDING TYPE OUTLET. IF THE PLUG DOES NOT FIT INTO THE OUTLET, CONTACT A QUALIFIED ELECTRICIAN TO INSTALL THE PROPER OUTLET. DO NOT CHANGE THE PLUG IN ANY WAY."

IMPORTANT - NOTICE D'INSTALLATION.

AVERTISSEMENT - POUR RÉDUIRE LES RISQUES DE BLESSURES GRAVES OU DE MORT :

- (1) LISEZ CETTE NOTICE ET CONFORMEZ-VOUS AUX INSTRUCTIONS.
- (2) NE POSEZ CET OUVERTE-PORTE QUE SUR UNE PORTE DE GARAGE CORRECTEMENT ÉQUILIBRÉE. UNE PORTE MAL ÉQUILIBRÉE PEUT CAUSER DES BLESSURES GRAVES. CONFIEZ LA RÉPARATION DES CÂBLES, DES RESSORTS ET DE TOUT AUTRE ÉLÉMENT À UN TECHNICIEN QUALIFIÉ AVANT D'ENTREPRENDRE L'INSTALLATION.
- (3) ENLEVEZ LES CORDES ET ENLEVEZ OU NEUTRALISEZ TOUT DISPOSITIF DE VERROUILLAGE SOLIDAIRE DE LA PORTE DE GARAGE AVANT L'INSTALLATION.
- (4) DANS LA MESURE DU POSSIBLE, INSTALLEZ L'OUVERTE-PORTE À AU MOINS 2.14M (7 PI) DU SOL. POSEZ LE DISPOSITIF DE DÉSCOUPLEMENT D'URGENCE À AU MOINS 1.83M (6 PI) DU SOL EN ÉVITANT LE CONTACT AVEC DES VÉHICULES POUR ÉVITER TOUT DÉCLENCHEMENT ACCIDENTEL.
- (5) NE BRANCHEZ PAS L'OUVERTE-PORTE AVANT D'Y ÊTRE AUTORISÉ PAR LA NOTICE.
- (6) INSTALLEZ LE BOUTON DE COMMANDE:
 - (I) À UN ENDROIT QUE L'ON PEUT VOIR DE L'EMBRASURE DE LA PORTE ;
 - (II) À UNE HAUTEUR MINIMALE DE 1.53M (5 PI) DU SOL - AFIN QUE LES JEUNES ENFANTS NE PUISSENT PAS L'ATTEINDRE,
 - (III) À L'ÉCART DES PIÈCES MOBILES DE LA PORTE.
- (7) APPOSEZ L'ÉTIQUETTE DE MISE EN GARDE RELATIVE AU DANGER DE HAPPEMENT À PROXIMITÉ DE BOUTON DE COMMANDE ET L'ÉTIQUETTE RELATIVE AU RÉGLAGE DE LA COMMANDE À UN EMPLACEMENT EN ÉVIDENCE - PAR EXEMPLE SUR LA PAROI INTÉRIEURE DE LA PORTE DE GARAGE OU SELON LES INSTRUCTIONS DE LA NOTICE D'INSTALLATION.
- (8) UNE FOIS L'OUVERTE-PORTE INSTALLÉ, LE SENS DE LA COURSE DOIT S'INVERSER LORSQUE LA PORTE ENTRE EN CONTACT AVEC UN OBJET D'UNE HAUTEUR DE 38 MM (1 1/2 PO) (OU UN MADRIER DE 2 X 4 PO DE SECTION, À PLAT) POSÉ SUR LE SOL.
- (9) Pour les produits munis d'un dispositif de desaccouplement manuel, indiquez à l'utilisateur final la procédure d'utilisation du dispositif.
- (10) Les instructions de câblage suivantes:
 - (i) "Cet opérateur est pas équipé pour le câblage permanent. Contactez un électricien qualifié pour installer un réceptacle approprié si l'on est pas disponible."
 - (II) POUR RÉDUIRE LES RISQUES D'ÉLECTROCUTION, CET APPAREIL EST ÉQUIPÉ D'UNE FICHE AVEC BROCHE DE MISE À LA TERRE. CETTE FICHE NE PEUT ÊTRE BRANCHÉE QUE DANS UNE PRISE AVEC MISE À LA TERRE. S'IL N'EST PAS POSSIBLE DE LA BRANCHER DANS LA PRISE, FAITES POSER UNE PRISE APPROPRIÉE PAR UN ÉLECTRICIEN QUALIFIÉ. NE PAS MODIFIER LA FICHE

6.1 Pre-Installation Requirements



WARNING! It is vital for the safety of persons to follow all instructions. Failure to comply with the installation instructions and the safety warnings may result in serious personal injury and/or property and remote control opener damage.

AVERTISSEMENT! pour la sécurité des usagers, il est essentiel de suivre toutes les instructions. Le non-respect des instructions d'installation et des avertissements de sécurité peut causer de graves blessures et/ou endommager l'appareil et la télécommande.

NOTE: Planetary chain equipment must be removed from the door prior to installation of GDO-12V1 HiRo™.

6.1.1 Door Operation

The door must be in good operating condition. The maximum effort to move the door up or down, from stationary, should not exceed 200 Newtons (44 lb force) at the bottom rail.

Lift the door to about halfway. When released, the door should stay in place supported entirely by its springs. Raise and lower the door to check for binding or sticking.

The door may need to be serviced to meet these requirements – refer to the door manufacturer's servicing instructions or contact an authorised dealer.

6.1.2 Unsuitable Door Types

The fitting of an opener to doors with removable mullions or doors incorporating a wicket door is not recommended (Fig. 6.1.1).

6.1.3 Position

The opener can be installed on either the right or left hand side of the door (when viewed from inside the garage). The opener is factory set for right hand side installation.

This opener must be installed in a dry position that is protected from the weather. Moisture or corrosion damage is not covered by the Warranty.

6.1.4 Power Supply

Properly earthed 3 pin single-phase power is required.



ELECTROCUTION! This operator is not equipped for permanent wiring. Contact a qualified electrician to install a suitable receptacle if one is not available.

ÉLECTROCUTION! Ce dispositif d'ouverture n'est pas conçu pour un câblage permanent. En l'absence de réceptacle approprié, contactez un électricien qualifié pour en installer un.



CAUTION: Do not connect opener to power source until instructed to do so.

ATTENTION: Ne branchez pas l'ouvre-porte avant d'y être autorisé par la notice.

6.1.5 Sideroom

The minimum sideroom required from the edge of the door curtain is $3\frac{3}{4}$ " to the inside of the door bracket, and $6\frac{1}{2}$ " to the wall. If the Battery Backup is to be fitted, at least $8\frac{1}{4}$ " to the bracket is required.

Therefore the recommended sideroom from the edge of the door curtain is 130mm to the inside of the door bracket, and 10" to the wall as per diagram (Fig 6.1.2) Please refer to Fig 6.1.3 for Windlock Doors.

NOTE: The door axle diameter must not exceed $1\frac{3}{8}$ ".

6.1.6 Forks

Attach and secure the three (3) forks (2) or (10) with the six (6) hex serration head screws (3) to the drive unit (1) (Fig. 6.1.3). All forks must be used and properly engaged into the drum of the door for the opener to work effectively.



Fig 6.1.1

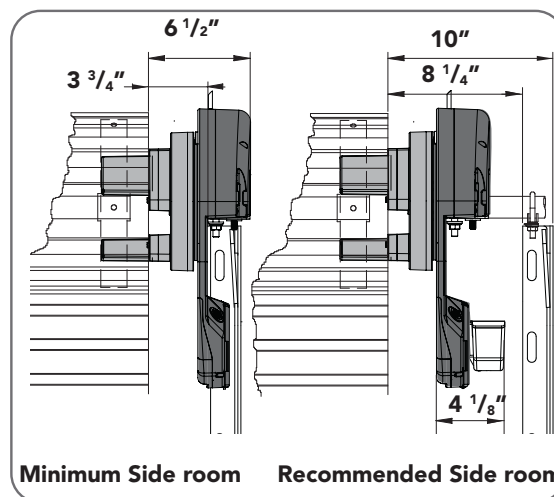

Fig 6.1.2

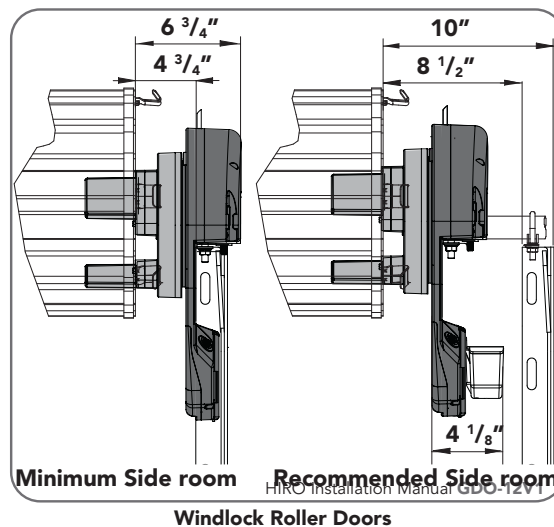

Fig 6.1.3

6.2 Door Preparation

6.2.1 Preparation

- a. Check the door's operation:
 - i. The door must travel smoothly and be easy to operate by hand.
 - ii. Adjust any tight or twisted guides.
 - iii. Clean the guides if there is any oil or wax present using a suitable white spirit. The only lubricant suitable for use on door guides is silicon spray. DO NOT use WD-40, RP-7, petroleum grease, or similar.
- b. Install the locking bar covers (7) if there are locking bar holes in the guides.
- c. Affix the warning labels supplied with this opener in a prominent place where they are clearly visible.
- d. Choose the side where the opener will be installed ensuring there is sufficient sideroom.

Check that the door is still balanced and smooth to operate. If it is not, the door may require servicing (refer to door manufacturer's instructions).

6.2.2 Pinning the Door to the drum:

Pinning the door's curtain to its drum maintains security when the opener is closed. If the curtain is not pinned the door can be partially opened manually.

- a. Fully close the door.
- b. Mark a minimum of two (2) drill holes on the drum to each end of the door (Fig. 6.2.1).
- c. Drill holes using 3.2mm (1/8") drill bit.
- d. Fit M10 x 32mm screws and washers (not supplied) to each of the four (4) holes. This screw should be positioned as low as possible in the groove, but make sure that it does not alter the curtain's normal lead in to the guide.

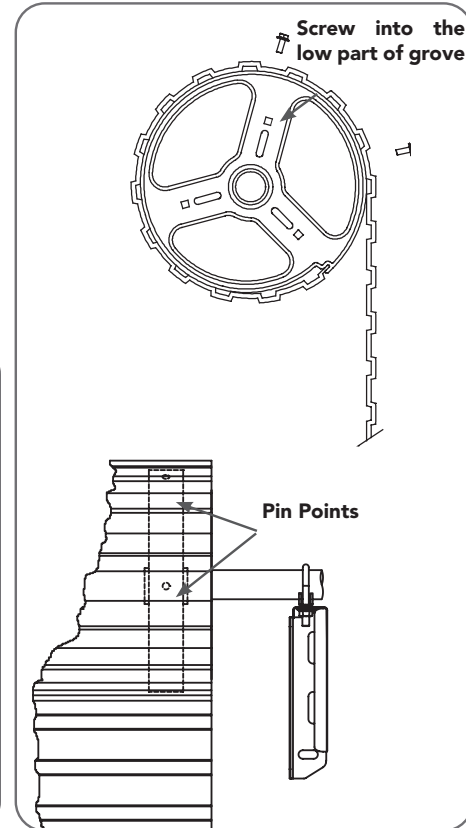
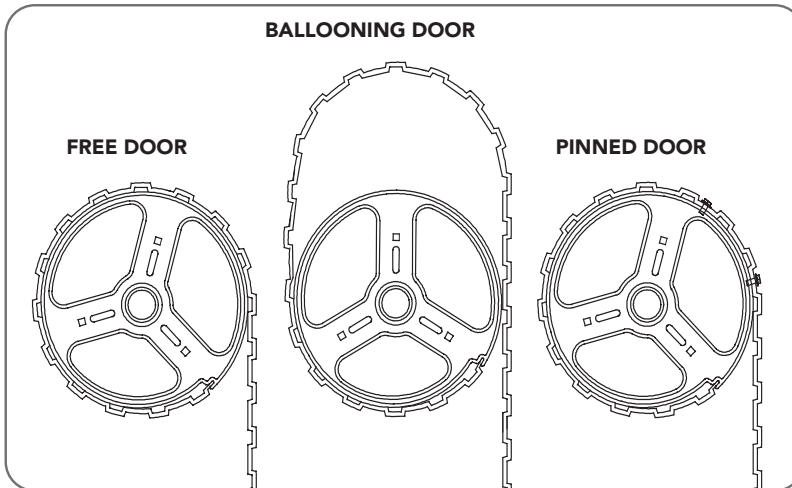

Fig 6.2.1

6.2.3 Door prop preparation

- a. At the end opposite to where the opener will be fitted, check that each nut securing the door axle, is tightened (to a torque setting of 40Nm) to the bracket. (Fig. 6.2)
- b. Open the door completely and tie safety ropes around the door roll approximately 300 mm from each end. Do not tie the ropes too tight as damage to the curtain may ensue.
- c. At the end where the opener is to be fitted, support the door with a safe and suitable lifter.

WARNING! Make sure the prop is snug under the door and is stable.
AVERTISSEMENT! Vérifier que le support est positionné correctement sous la porte et ne risque pas de tomber.

- d. At the end where the opener will be fitted, use pen to mark the position of the saddle on the door bracket and the position of the door bracket on the wall to assist in reassembling.
- e. Remove the bolts and saddle from the door bracket.
- f. Raise the door off the door bracket and secure in the support.

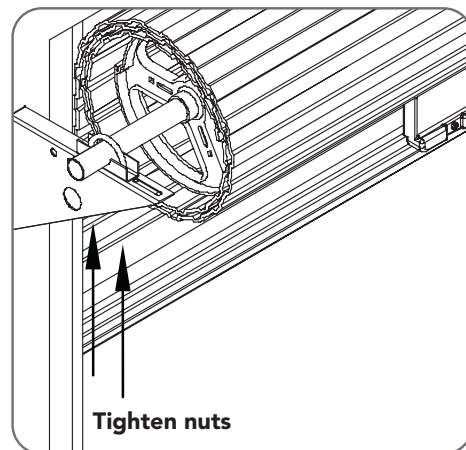

Fig 6.2.2

NOTE - For minimum sideroom installations, the door may have to be taken down.

6.3 Fitting the Opener

6.3.1 Mounting The Opener

- Check the drive gear rotates freely, by pulling the string handle down (there will be a click) to disengage opener. Then move the forks from side to side by hand.
- Slide the opener over the door axle and into the drum of the door (**Fig. 6.3**).
- Ensure the internal gear is pushed in as far as possible (without interfering with the door curtain) and that the door drum's wheel spokes are completely between the opener's drive forks.
- Evenly tighten the supplied nuts on the clamp assembly of the opener to a torque setting of 40Nm.
- Remove the safety rope and door stand or prop.
- Connect the power cord to a suitable powerpoint, but **DO NOT** switch on.
- Secure the power cord away from any moving object (e.g the door) with the cable clip supplied.
- With the opener still disengaged, pull the door up and down to make sure it runs freely.

NOTE - If the manual release handle is more than 6 feet from floor level when the opener is installed, extend the handle to a height less than 6 feet.

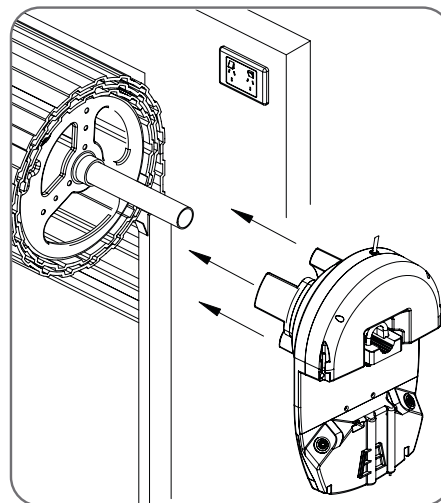

Fig 6.3



WARNING! The opener must not be used with a door incorporating a wicket door.
AVERTISSEMENT! Ce moteur ne doit pas être utilisé avec une porte de garage avec portillon



WARNING! Garage doors, door springs, brackets and their hardware are under extreme tension and can cause serious personal injury. Do not attempt any garage door adjustment.

AVERTISSEMENT! Les portes de garage, les ressorts de porte, les pattes de fixation et les éléments matériels sont soumis à une tension extrême et peuvent blesser gravement. Ne tentez pas de régler la porte de garage par vous-même.

6.4 Safety Beam Installation

IMPORTANT NOTE: The Safety Beam must be installed and connected before the travel limits are set.

ATTENTION: Le faisceau de sécurité doit être installé et connecté avant de définir les fins de course.

6.4.1 Safety Infra-Red Beam Kit (P/N 62047)

A Safety Beam extends across the door opening. This Safety Beam is designed to detect an obstruction while the door is closing and to send a signal to the door operator to reverse or stop the door movement. **Install the Safety Beam indoor only.**

6.4.2 Assembling the Mounting Bracket

- Place the round screw (3) through the Bracket (5). Attach the Safety Beam Transmitter (TX) using four (4) M3 x 5 Taptite screws (4) (Fig. 6.4.1).
- Connect the mounting bracket (2) to the Bracket (5) using the wing nut (8) onto the round screw (3). Secure the adjustment bracket (6) to the mounting bracket (2) using two (2) screws (3) and nuts (7).
- Repeat steps (a) and (b) to assemble the Safety Beam Receiver (RX).
- Locate the Safety Beam in a strategic location in the door opening. **We recommend** that the sensor is placed no higher than 6" and no lower than 5" above the floor level. The mounting surface should be rigid.

6.4.3 Aligning the Transmitter and receiver

- Wire the PE Beams as per Wiring Diagram (Fig. 6.4.2).
- Power up the opener with the safety beams connected. The green LED on the transmitter should turn ON to indicate power is present.
- If the receiver is connected to power and the red LED is flashing while the green LED on the transmitter is on, the transmitter and receiver are not aligned.
- Make horizontal and/or vertical adjustment on the transmitter and/or the receiver (Fig 6.4.3) until the red LED on the receiver turns on, indicating alignment.

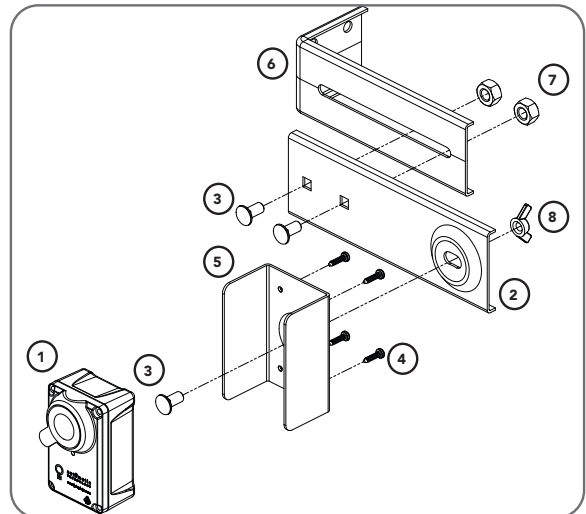

Fig.6.4.1

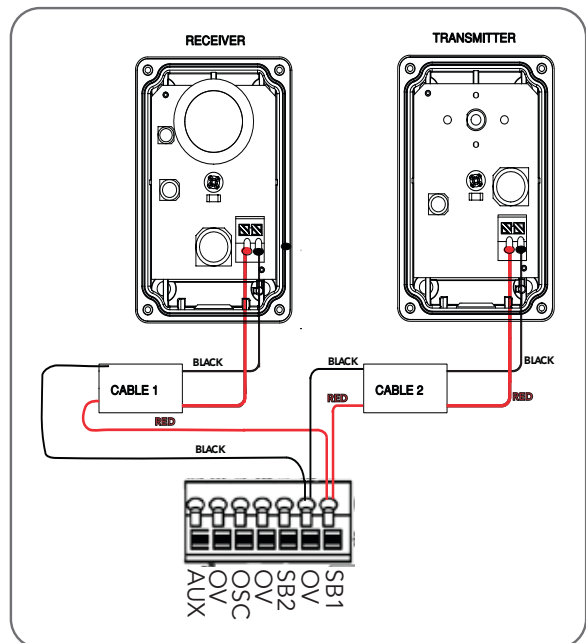

Fig.6.4.2



WARNING: When the Safety Beam is fitted, the doorway must be clear of all obstructions and persons at all times. Incorrect location of the safety beams may not give safety protection at all times. Check to make sure that the height of the beam gives maximum protection.

AVERTISSEMENT: Lorsque le faisceau de sécurité est en place, le passage doit être dégagé en permanence. Si le faisceau est mal placé, la sécurité ne peut pas être assurée correctement. Assurez-vous que la hauteur du faisceau assure une protection maximale.



WARNING: Connect the Safety Beam as per diagram in Fig 6.4.2. Tampering with the Safety Beam could result in serious personal injury and/or property damage and will void the warranty.

AVERTISSEMENT: Raccordez le faisceau de sécurité conformément au schéma Fig. 6.4.2. Saboter le faisceau de sécurité présente un risque de blessure corporelle grave et/ou de dommages matériels, et annule la garantie.

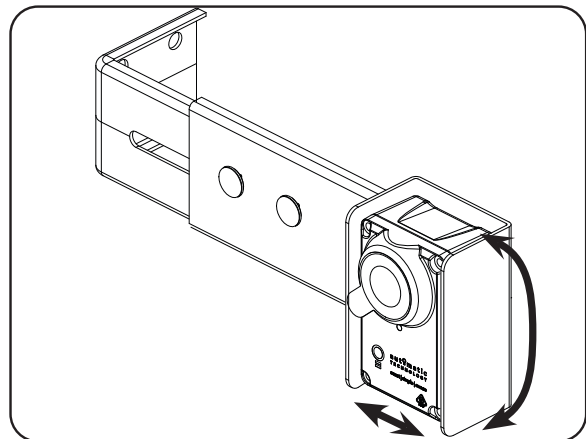





Fig 6.4.3

6.5 Setting Speed and Limits

6.5.1 Set the Limit Positions and adjust drive speed:

SETTING LIMITS

tip When setting the Close limit, ensure the position is when the door makes first contact with the ground. Alternatively for the Open limit the position should be at the height of the garage opening.

STEP ONE	STEP TWO
   <p>Switch power on. BLUE LED will flash</p>	 <p>To move the door to the halfway point.</p>

tip HELPFUL TIP: If the door moves in opposite direction, press and hold the OPEN and CLOSE buttons at the same time (approx 3 seconds) until you hear a beep. This will reverse the direction of the motor.













BEEPER	SPEED MODE
3 x 	FAST (Default)
2 x 	MEDIUM
1 x 	SLOW

Fig.6.5.1

CLOSE LIMIT POSITION

STEP ONE	STEP TWO
   <p>HOLD</p> <p>Take note of the speed as door moves</p>	<p>If Close speed not suitable, release button, THEN</p>    <p>HOLD</p> <p>Each press changes speed as per table</p> <p>(Fig.6.5.1)</p>

STEP THREE	STEP FOUR
   <p>RELEASE HOLD</p> <p>When at desired speed Press to close door</p>	 <p>When door near close, single presses inch door</p> <p>CLOSE limit should be when rubber strip touches the ground</p>

WARNING! In setting the close limit position, do not force the door into the floor with excessive force, as this can interfere with the ease of operation of the manual release mechanism.

AVERTISSEMENT! Ne pas forcer la porte contre le sol lors du réglage de fin de course, car une force excessive peut entraver le fonctionnement du système de déclenchement manuel.

STEP FIVE

If door overshoots

















Press Press to position Press to set

OPEN LIMIT POSITION

STEP ONE	STEP TWO
   <p>HOLD</p> <p>Take note of the speed as door moves</p>	<p>If Open speed not suitable, RELEASE button, THEN</p>    <p>HOLD</p> <p>Each press changes speed as per table</p> <p>(Fig.6.5.1)</p>

STEP THREE	STEP FOUR
   <p>RELEASE HOLD</p> <p>When at desired speed Press to open door</p>	 <p>When door near open, single presses inch door</p> <p>OPEN limit should be the height of the garage opening</p>

WARNING! The door will automatically close, open and close again after the next step. Ensure that nothing is in the door's path.

AVERTISSEMENT! La porte va se fermer puis s'ouvrir automatiquement, avant de se fermer. S'assurer que rien ne bloque l'ouverture ou la fermeture de la porte.

STEP FIVE

If door overshoots







Press Press to position Press to set

Door will open & close to calculate safety obstruction settings

6.5 Setting Speed and Limits

NOTE: If unhappy with the speed or travel limit setting, restart this procedure by clearing the door limit positions as per below first.

6.5.2 Clearing the Door Limit Positions

STEP ONE		STEP TWO	
	Switch power OFF		Switch power ON
STEP THREE			
	SET Close & Open limits	LIMIT LED will flash	

tip **HELPFUL TIP:** Alternatively set travel limits using a Remote Control Transmitter, allowing free movement around the garage to better assess the desired limit positions. See Appendix D.

tip **HELPFUL TIP:** The door can be set to a partial open position and programmed to a Remote Control Transmitter button. Refer to Appendix B.

6.5.3 Re-profiling the Door

tip Re-profiling is a simple way of re-learning the travel characteristics of a previously setup Limit Switch travel. Re-profiling is used when travel characteristic change due to mechanical adjustments.

To initiate a re-profile: LIMITS must already be set.

STEP ONE		STEP TWO	
	Press repeatedly		till LIMIT LED lit
		LAMP AUX PAINT VAC A/C BEAM OBST	
One of the word LED's will light up			
STEP THREE			
	Press repeatedly		till OBST LED lit
			HOLD for 2 secs
The shutter will open and close by itself to record profile			

6.6 Auto-Close

6.6.1 Auto-Close

Auto-Close mode is a function that automatically closes the door after a pre-set time. Safety beams must be installed in order to run the Auto-Close function. There are two types of Auto-Close available:

- (i) Standard auto-close - the door will Auto-Close after a programmed time. In this mode the timer starts to countdown as soon as the door is fully open. This function is useful in case the safety beam does not get triggered.
- (ii) Safety Beam triggered auto-close - the door will auto-close after a programmed time. In this mode the timer starts counting down only when the safety beam is triggered. ie car leaving the garage.

TO ENABLE THE AUTO-CLOSE FUNCTION

STEP ONE			
Remove controls cover			
	Press repeatedly		till Spanner LED is lit
		LAMP AUX PAINT VAC A/C BEAM OBST	
One of the word LED's will light up			
STEP TWO		STEP THREE	
	Press repeatedly		till A/C LED lit
			Press x 2 PE Auto
			Press to enter parameter
x 3 Std Auto			
STEP FOUR			
	Press to move through options as per table		Press to save
		OR	
		Press to leave unchanged	

LED Indicators	Parameter	OPEN	OPEN & STOP	STOP	CLOSE & STOP	CLOSE
A/C LED	A/C Function	90s	60s	30s	15s	OFF
A/C & BEAM LED'S	PE A/C Function	60s	30s	15s	5s	OFF

6.7 Safety Testing & Accessories



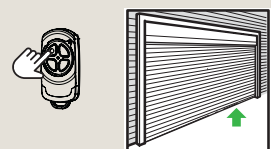
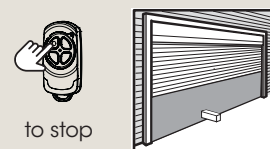
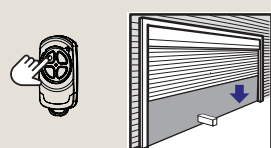
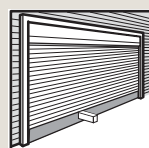

HELPFUL TIP: To conduct safety testing with ease precode a remote control button first. Refer to coding transmitters in next section.

6.7.1 Testing the Close Cycle

<p>STEP ONE</p> <p>when the door is closed</p>  <p>Press to open door halfway</p>	<p>STEP TWO</p>  <p>to stop</p> <p>Place a piece of 2" x 4" timber laid flat in centre of opening</p>
<p>STEP THREE</p>  <p>to close</p>	<p>STEP TWO</p>  <p>When door contacts object, the door must STOP and REVERSE!</p>

IF THE DOOR DOES NOT PROPERLY REVERSE: Check that the close limit position is where the door touches the ground. If the door STOPS but does not reverse, decrease the force pressure. (Appendix A)

6.7.3 Installation of Premium Wall Control

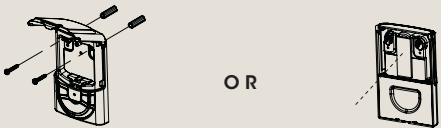
<p>STEP ONE</p>  <p>Remove the mounting hardware from inside cover</p>	<p>STEP TWO</p>  <p>Pull the battery tab to commission</p>
<p>STEP THREE</p>  <p>Pre-drill holes, using 6mm drill bits</p> <p>OR</p> <p>Place velcro on back of cover</p> <p>Mount at least 5 feet off the ground, and make sure the door is visible from this location. Follow the instructions on how to set transmitter codes in next section.</p>	





ELECTROCUTION! Be mindful not to drill into existing wiring as this may result in serious harm and or death.



CAUTION: Take care when testing the safety obstruction force. Excessive force may cause serious personal injury and/or property damage can result from failure to follow this warning.

ATTENTION: Testez la résistance aux obstacles avec précaution. Une force excessive présente un risque de blessure corporelle grave et/ou d'endommager le matériel si vous ne respectez pas cet avertissement.

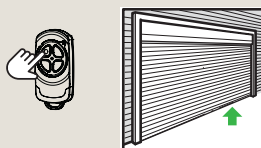
6.7.2 Testing the Open Cycle

<p>STEP ONE</p> <p>when the door is closed</p>  <p>Press to open door</p>	<p>STEP TWO</p>  <p>When the door reaches halfway, grab the bottom rail firmly. Door should STOP!</p>
--	---

IF THE DOOR DOES NOT STOP: The Force pressure may be excessive and need adjusting. Follow steps to decrease force pressure. (Appendix A)



IMPORTANT WARNING! If the door is closing and is unable to re-open when obstructed, discontinue use. Do not use a door with faulty obstruction sensing. Repair fault and re-test before using.

AVERTISSEMENT IMPORTANT! Si la porte est en train de se refermer et ne peut pas être rouverte, arrêtez de l'utiliser. N'utilisez pas une porte dont les détecteurs d'obstacles sont défectueux. Réparez-les et refaites un essai.

IMPORTANT WARNING

LOCATE THE WALL MOUNTED REMOTE CONTROL:

- (1) WITHIN SIGHT OF DOOR.
- (2) AT MINIMUM HEIGHT OF 5 FEET ABOVE FLOORS, LANDINGS, STEPS OR OTHER ADJACENT WALKING SURFACE SO SHALL CHILDREN ARE NOT ABLE TO REACH IT, AND
- (3) AWAY FROM MOVING PARTS OF THE DOOR.
- (4) PLACE THE ATTACHED ENTRAPMENT WARNING LABEL ON WALL NEXT TO WALL MOUNTED TRANSMITTER. USE AN ADDITIONAL MECHANICAL MEANS (PLATE, BOARD, ETC.), WHICH CAN SECURE THE LABELS TO SURFACES TO WHICH THE ADHESIVE WILL NOT ADHERE.
- (5) DO NOT REMOVE OR PAINT OVER THIS LABEL.

PLACEZ LA TÉLÉCOMMANDE MURALE :

- (1) EN VUE DE LA PORTE.
- (2) À UNE HAUTEUR D'AU MOINS 1,50 M (5 PIEDS) AU-DESSUS DU SOL, DU PERRON, DES MARCHES, ETC. AFIN QUE LES PETITS ENFANTS NE PUISSENT PAS L'ATTEINDRE,
- (3) ET À DISTANCE DES ÉLÉMENTS MOBILES DE LA PORTE.
- (4) PLACEZ L'ÉTIQUETTE AVERTISSANT DU RISQUE DE SE FAIRE PIÉGER SUR LE MUR À PROXIMITÉ DE L'ÉMETTEUR. UTILISEZ UN SUPPORT PHYSIQUE SUPPLÉMENTAIRE (PLAQUE, PANNEAU, ETC.) PERMETTANT DE FIXER LES ÉTIQUETTES SI ELLES N'ADHÉRENT PAS À LA SURFACE DU MUR.
- (5) CETTE ÉTIQUETTE NE DOIT PAS ÊTRE RETIRÉE NI PEINTE.

6.8 Coding Transmitters

TRANSMITTERS COMPLIANCE STATEMENT

TRANSMITTERS COMPLY WITH ALL UNITED STATES AND CANADIAN LEGAL REQUIREMENTS AS OF THE DATE OF MANUFACTURE. TO COMPLY WITH **FCC PART 15** AND OR **RSS 210 INNOVATION, SCIENCE AND ECONOMIC DEVELOPMENT CANADA** RULES, ADJUSTMENT OR MODIFICATIONS OF THIS RECEIVER AND / OR TRANSMITTER ARE PROHIBITED, EXCEPT FOR CHANGING THE CODE SETTING OR REPLACING THE BATTERY. THERE ARE NO OTHER USER SERVICEABLE PARTS. TESTED TO COMPLY WITH FCC STANDARD FOR HOME OR OFFICE USE. THIS DEVICE CONTAINS LICENCE-EXEMPT TRANSMITTER(S)/RECEIVER(S) THAT COMPLY WITH INNOVATION, SCIENCE AND ECONOMIC DEVELOPMENT CANADA'S LICENCE-EXEMPT RSS(S). OPERATION IS SUBJECT TO THE FOLLOWING TWO CONDITIONS:

(1) THIS DEVICE MAY NOT CAUSE INTERFERENCE.

(2) THIS DEVICE MUST ACCEPT ANY INTERFERENCE, INCLUDING INTERFERENCE THAT MAY CAUSE UNDESIRE OPERATION OF THE DEVICE.

NOTE: THIS EQUIPMENT HAS BEEN TESTED AND FOUND TO COMPLY WITH THE LIMITS FOR A CLASS B DIGITAL DEVICE, PURSUANT TO PART 15 OF THE FCC RULES. THESE LIMITS ARE DESIGNED TO PROVIDE REASONABLE PROTECTION AGAINST HARMFUL INTERFERENCE IN A RESIDENTIAL INSTALLATION. THIS EQUIPMENT GENERATES, USES AND CAN RADIATE RADIO FREQUENCY ENERGY AND, IF NOT INSTALLED AND USED IN ACCORDANCE WITH THE INSTRUCTIONS, MAY CAUSE HARMFUL INTERFERENCE TO RADIO COMMUNICATIONS. HOWEVER, THERE IS NO GUARANTEE THAT INTERFERENCE WILL NOT OCCUR IN A PARTICULAR INSTALLATION. IF THIS EQUIPMENT DOES CAUSE HARMFUL INTERFERENCE TO RADIO OR TELEVISION RECEPTION, WHICH CAN BE DETERMINED BY TURNING THE EQUIPMENT OFF AND ON, THE USER IS ENCOURAGE TO TRY TO CORRECT THE INTERFERENCE BY ONE OR MORE OF THE FOLLOWING MEASURES:

- REORIENT OR RELOCATE THE RECEIVING ANTENNA
- INCREASE THE SEPARATION BETWEEN THE EQUIPMENT AND RECEIVER
- CONNECT THE EQUIPMENT INTO AN OUTLET ON A CIRCUIT DIFFERENT FROM THAT TO WHICH THE RECEIVER IS CONNECTED. CONSULT YOUR LOCAL DEALER OR AN EXPERIENCED RADIO/TV TECHNICIAN FOR HELP.

DÉCLARATION DE CONFORMITÉ DE L'ÉMETTEUR

LES ÉMETTEURS SONT CONFORMES À TOUTES LES EXIGENCES LÉGALES DES ÉTATS-UNIS ET DU CANADA À LA DATE DE FABRICATION. POUR SE CONFORMER AUX RÈGLES **D'INNOVATION, SCIENCE ET DÉVELOPPEMENT ÉCONOMIQUE CANADA PARTIE 15 ET OU RSS 210 DE FAC**. LES RÉGLAGES OU MODIFICATIONS DE CE RÉCEPTEUR ET/OU ÉMETTEUR SONT INTERDITS, À L'EXCEPTION DU CHANGEMENT DE CODE OU DU REMPLACEMENT DE LA BATTERIE. AUCUNE AUTRE PIÈCE NE PEUT ÊTRE RÉPARÉE PAR L'UTILISATEUR. CONFORMITÉ À LA NORME FCC TESTÉE POUR UN USAGE DOMESTIQUE OU DE BUREAU. L'ÉMETTEUR/RÉCEPTEUR EXEMPT DE LICENCE CONTENU DANS LE PRÉSENT APPAREIL EST CONFORME AUX CNR D'INNOVATION, SCIENCES ET DÉVELOPPEMENT ÉCONOMIQUE CANADA APPLICABLES AUX APPAREILS RADIO EXEMPTS DE LICENCE. L'EXPLOITATION EST AUTORISÉE AUX DEUX CONDITIONS SUIVANTES :

L'APPAREIL NE DOIT PAS PRODUIRE DE BROUILLAGE ;

L'APPAREIL DOIT ACCEPTER TOUT BROUILLAGE RADIOÉLECTRIQUE SUBI, MÊME SI LE BROUILLAGE EST SUSCEPTIBLE D'EN COMPROMETTRE LE FONCTIONNEMENT.

REMARQUE: CET ÉQUIPEMENT A ÉTÉ TESTÉ ET DÉCLARÉ CONFORME AUX LIMITATIONS APPLICABLES À UN APPAREIL NUMÉRIQUE DE CLASSE B, CONFORMÉMENT AUX DISPOSITIONS DE LA PARTIE 15 DES RÈGLES DE LA FCC. CES LIMITATIONS VISENT À ASSURER UNE PROTECTION SUFFISANTE CONTRE LES INTERFÉRENCES DANS UNE INSTALLATION RÉSIDENIELLE. CET ÉQUIPEMENT DÉGAGE, UTILISE ET PEUT DIFFUSER DES ONDES RADIO. S'IL N'EST PAS INSTALLÉ ET UTILISÉ CONFORMÉMENT AUX INSTRUCTIONS, LES INTERFÉRENCES PEUVENT PERTURBER LES COMMUNICATIONS RADIO. IL N'Y A TOUTEFOIS AUCUNE GARANTIE QUE DES INTERFÉRENCES NE SE PRODUIRONT PAS DANS UNE INSTALLATION DONNÉE. SI CET ÉQUIPEMENT VIENT À CAUSER DES INTERFÉRENCES AVEC LA RÉCEPTION DE LA RADIO OU DE LA TÉLÉVISION, CE QUI PEUT ÊTRE DÉTERMINÉ EN L'ÉTEIGNANT ET EN LE RALLUMANT, L'UTILISATEUR EST INVITÉ À Y REMÉDIER EN PRENANT UNE OU PLUSIEURS DES MESURES SUIVANTES :









- RÉORIENTER OU DÉPLACER L'ANTENNE DE RÉCEPTION ;
- ÉLOIGNER L'ÉQUIPEMENT DU RÉCEPTEUR ;
- BRANCHER L'ÉQUIPEMENT DANS UNE PRISE DE COURANT D'UN CIRCUIT ÉLECTRIQUE DIFFÉRENT. LE CAS ÉCHÉANT, CONSULTEZ VOTRE REVENDEUR OU UN TECHNICIEN RADIO/TV EXPÉRIMENTÉ.

6.8 Coding Transmitters

6.8.1 Remote Control Transmitter Button to Operate Door



The opener can only be operated from remote controllers that have been programmed into its memory. Up to 64 remotes can be programmed.

STEP ONE	STEP TWO
 remove controls cover	 Press repeatedly till CODE LED is lit
STEP THREE	
 OR  Press repeatedly till all three LED's are lit	
STEP FOUR	STEP FIVE
 HOLD to enter coding	 HOLD for 3 sec RELEASE HOLD for 3 sec Release both buttons
STEP SIX	
 To exit coding Then replace controls cover  Press to test	





HELPFUL TIP: Refer to Appendix for Additional Transmitter coding functions



WARNING! The manufacturer is not responsible for any radio or TV interference caused by unauthorized modifications to this equipment. Such modifications could void the user's authority to operate the equipment.

AVERTISSEMENT! Le fabricant n'est pas responsable des éventuelles interférences avec la réception de la radio ou de la TV due à une modification de cet équipement effectuée sans autorisation. De telles modifications peuvent invalider le droit à utiliser l'équipement.

6.8.2 Erasing Programmed Codes

STEP ONE	STEP TWO
Switch power OFF  +  HOLD Switch power ON fill Code LED flashes	Follow Section 6.7.1 to store new transmitter codes





6.8.3 Selecting The Function To Be Coded

NOTE: Only the function of the existing transmitter button can be assigned to new transmitter. Please read instructions prior to proceeding - there is a time-out facility for security reasons.

- Using the existing transmitter, operate the Shutter with the transmitter button which has the function to be coded (e.g. Button 1 has been coded with the OSC function assigned).
- If the button's function activates the Shutter (PART, OSC, CLS, STP or OPN) wait for the Shutter to complete its cycle.



Remotely coding works when you have a pre-coded remote control and are in range of the opener.

STEP ONE	STEP TWO
 Take a pre-coded remote and press the button to duplicate	 Use a pen, HOLD for 2 sec the middle button through the coding hole
STEP THREE	STEP FIVE
 Opener flashes & beeps HOLD for 3 sec RELEASE HOLD for 3 sec RELEASE Take new remote	 Opener stops flashing & beeping Press to test

6.8.4 Installing a wall button control

STEP ONE	STEP TWO
 remove controls cover	 Press repeatedly till CODE LED is lit
STEP THREE	
 OR  Press repeatedly till all three LED's are lit	
STEP FOUR	STEP FIVE
 HOLD to enter coding	 HOLD for 3 sec RELEASE HOLD for 3 sec Release both buttons
STEP FIVE	
 To exit coding Then replace controls cover	

6.9 Attach Warning Labels

6.9.1 Placement of Warning Labels / Placards

- Attach the entrapment warning label (Residential) OR placard (Commercial) on the wall near the door control with tacks or staples at a minimum height of 5 feet above floors, landings, steps or other adjacent walking surface so shall children are not able to reach it.
- **DO NOT REMOVE OR PAINT OVER THIS PLACARD.**
- **NE PAS ENLEVER CETTE ÉTIQUETTE NI LA COUVRIR DE PANNEAU**

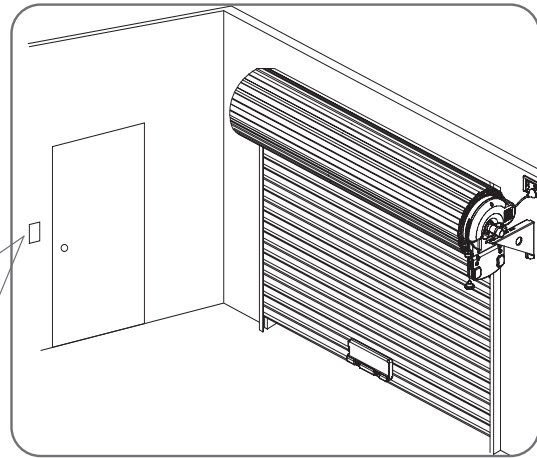
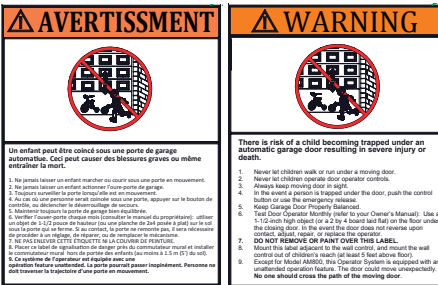

Fig.6.8.1



Residential Labels



Commercial Placards

7. Operation Instructions

IMPORTANT SAFETY INSTRUCTIONS

WARNING! TO REDUCE THE RISK OF SEVERE INJURY OR DEATH:

- (1) **READ AND FOLLOW ALL INSTALLATION INSTRUCTIONS.**
- (2) NEVER LET CHILDREN OPERATE OR PLAY WITH DOOR CONTROLS. KEEP THE REMOTE CONTROL AWAY FROM CHILDREN.
- (3) ALWAYS KEEP THE MOVING DOOR IN SIGHT AND AWAY FROM PEOPLE AND OBJECTS UNTIL IT IS COMPLETELY CLOSED. NO ONE SHOULD CROSS THE PATH OF THE MOVING DOOR.
- (4) **NEVER GO UNDER A STOPPED, PARTIALLY OPEN DOOR.**
- (5) TEST DOOR OPENER MONTHLY. THE GARAGE DOOR **MUST** REVERSE ON CONTACT WITH A 1-1/2-INCH HIGH OBJECT (OR A 2 BY 4 BOARD LAID FLAT) ON THE FLOOR. AFTER ADJUSTING EITHER THE FORCE OR THE LIMIT OF TRAVEL, RETEST THE DOOR OPENER. FAILURE TO ADJUST THE OPENER PROPERLY INCREASES THE RISK OF SEVERE INJURY OR DEATH.
- (6) FOR PRODUCTS HAVING AN EMERGENCY RELEASE, WHEN POSSIBLE, USE THE EMERGENCY RELEASE ONLY WHEN THE DOOR IS CLOSED. USE CAUTION WHEN USING THIS RELEASE WITH THE DOOR OPEN. WEAK OR BROKEN SPRINGS ARE CAPABLE OF INCREASING THE RATE OF DOOR CLOSURE AND INCREASING THE RISK OF SEVERE INJURY OR DEATH.
- (7) **KEEP GARAGE DOORS PROPERLY BALANCED.** SEE OWNER'S MANUAL. AN IMPROPERLY BALANCED DOOR INCREASES THE RISK OF SEVERE INJURY OR DEATH. HAVE A QUALIFIED SERVICE PERSON MAKE REPAIRS TO CABLES, SPRING ASSEMBLIES, AND OTHER HARDWARE.
- (8) THIS PRODUCT CONTAINS A LITHIUM BUTTON/COIN CELL BATTERY. IF A NEW OR USED LITHIUM BUTTON/COIN CELL BATTERY IS SWALLOWED OR ENTERS THE BODY, IT CAN CAUSE SEVERE INTERNAL BURNS AND CAN LEAD TO DEATH IN AS LITTLE AS 2 HOURS. ALWAYS COMPLETELY SECURE THE BATTERY COMPARTMENT. IF THE BATTERY COMPARTMENT DOES NOT CLOSE SECURELY, STOP USING THE PRODUCT, REMOVE THE BATTERIES, AND KEEP IT AWAY FROM CHILDREN. IF YOU THINK BATTERIES MIGHT HAVE BEEN SWALLOWED OR PLACED INSIDE ANY PART OF THE BODY, **SEEK IMMEDIATE MEDICAL ATTENTION.**

(9) SAVE THESE INSTRUCTIONS.

AVERTISSEMENT !

POUR RÉDUIRE LE RISQUE DE BLESSURES GRAVES, VOIRE DE MORT:

- (1) **LISEZ ATTENTIVEMENT TOUTES LES INSTRUCTIONS D'INSTALLATION.**
- (2) NE LAISSEZ JAMAIS LES ENFANTS UTILISER LES COMMANDES DE LA PORTE OU JOUER AVEC. LA TÉLÉCOMMANDE DOIT RESTER HORS DE PORTÉE DES ENFANTS.
- (3) GARDEZ TOUJOURS LA PORTE EN MOUVEMENT DANS VOTRE LIGNE DE VISION, ET VEILLEZ À CE QU'ELLE RESTE ENTIÈREMENT DÉGAGÉE JUSQU'À SA FERMETURE COMPLÈTE. PERSONNE NE DOIT SE TENIR DANS LE PASSAGE PENDANT QUE LA PORTE EST EN MOUVEMENT.
- (4) **NE STATIONNEZ JAMAIS SOUS UNE PORTE PARTIELLEMENT OUVERTE.**
- (5) TESTEZ LE DISPOSITIF D'OUVERTURE UNE FOIS PAR MOIS. LA PORTE DOIT **OBLIGATOIREMENT** INVERSER SA COURSE EN CAS DE CONTACT AVEC UN OBJET DE 25 À 40 MM (1-1/2") (OU UNE PLANCHE DE 5 X 10 CM [2X4"] POSÉE À PLAT) AU MILIEU DU PASSAGE. APRÈS AVOIR RÉGLÉ LA FORCE OU LA LIMITE DE COURSE, REFAITES UN ESSAI DU SYSTÈME D'OUVERTURE DE PORTE. LE DISPOSITIF D'OUVERTURE DOIT ÊTRE BIEN RÉGLÉ AFIN DE RÉDUIRE LE RISQUE DE BLESSURES GRAVES, VOIRE DE MORT.
- (6) DANS LE CAS DES PRODUITS ÉQUIPÉS D'UN DÉBLOCAGE D'URGENCE, UTILISEZ-LE DANS LA MESURE DU POSSIBLE UNIQUEMENT QUAND LA PORTE EST FERMÉE. SOYEZ PRUDENT SI VOUS ACTIONNEZ CE DISPOSITIF DE DÉBLOCAGE ALORS QUE LA PORTE EST OUVERTE. DES RESSORTS FAIBLES OU CASSÉS RISQUENT D'ACCÉLÉRER LA FERMETURE DE LA PORTE ET DE CAUSER DES BLESSURES GRAVES, VOIRE DE PRÉSENTER UN DANGER DE MORT.
- (7) **LES PORTES DE GARAGE DOIVENT TOUJOURS ÊTRE CORRECTEMENT ÉQUILIBRÉES.** REPORTEZ-VOUS AU MANUEL. UNE PORTE MAL ÉQUILIBRÉE PRÉSENTE UN DANGER DE BLESSURES GRAVES, VOIRE DE MORT. LES RÉPARATIONS DES CÂBLES, DES ASSEMBLAGES À RESSORT ET AUTRES ÉLÉMENTS MATÉRIELS DOIVENT ÊTRE EFFECTUÉES PAR UN TECHNICIEN QUALIFIÉ.
- (8) CE PRODUIT CONTIENT UNE PILE BOUTON/MONNAIE AU LITHIUM. SI UNE PILE BOUTON/MONNAIE AU LITHIUM NEUVE OU USAGÉE EST AVALÉE OU PÉNÈTRE DANS LE CORPS, ELLE PEUT CAUSER DE GRAVES BRÛLURES INTERNES ET PEUT ENTRAÎNER LA MORT EN DEUX HEURES SEULEMENT. TOUJOURS SÉCURISER COMPLÈTEMENT LE COMPARTIMENT DES PILES. SI LE COMPARTIMENT DES PILES NE SE FERME PAS CORRECTEMENT, ARRÊTEZ D'UTILISER LE PRODUIT, RETIREZ LES PILES ET GARDEZ-LE HORS DE PORTÉE DES ENFANTS. SI VOUS PENSEZ QUE DES PILES ONT PU ÊTRE AVALÉES OU PLACÉES DANS UNE PARTIE QUELCONQUE DU CORPS, **CONSULTEZ IMMÉDIATEMENT UN MÉDECIN.**

(9) CONSERVEZ CES INSTRUCTIONS EN LIEU SÛR.

7.1 How to Use Your Operator

For maximum efficiency of your operator, your garage door must be in good operating condition. An annual service of your garage door by door professional is recommended.

CAUTION: Activate the operator only when the door is in full view, free of obstructions and with the operator properly adjusted. No one should enter or leave the garage while the door is in motion. Do not allow children to play near the door.

ATTENTION: Activez le dispositif de commande uniquement lorsque la porte est en pleine vue, dégagée et avec le dispositif correctement réglé. Personne ne doit entrer ou sortir du garage pendant que la porte est en mouvement. Ne pas laisser les enfants jouer près de la porte.

WARNING! This operator has a grounding type plug and there are no user serviceable parts inside this operator.

AVERTISSEMENT! Ce dispositif de commande est pourvu d'une broche de mise à la terre et ne comporte aucune pièce réparable par l'utilisateur.

7.1.1 To Operate the opener:

- Press the programmed transmitter button until your door begins to move (usually 2 seconds). Make sure you can see the door when you use the transmitter (**Fig 7.1.1**).
- If you are in a vehicle you should aim the transmitter through your windscreen as shown.
- Check that the door is fully open or closed before you drive in or away.
- If you press the transmitter whilst the door is moving the door will stop. The next press of the transmitter will move the door in the opposite direction.

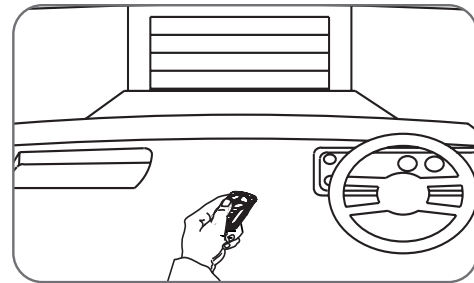

Fig.7.1.1

7.1.2 Replacing the Battery: 3V Lithium Battery CR2032.

BATTERY IN PREMIUM REMOTE CONTROL

tip Battery Type: 1 x CR2032.

STEP ONE		Light Status	Battery
<p>Check Light Status Table</p>	Solid	OK	
	Flashing	Replace	
	No light	Replace	

STEP TWO	STEP THREE
<p>Use screwdriver to remove screws and open</p>	<p>Use non-metallic object to push out.</p>

BATTERY IN WALL MOUNTED TRANSMITTER

tip Battery Type: 1 x CR2032.

STEP ONE		Light Status	Battery
<p>Check Light Status Table</p>	Solid	OK	
	Flashing	Replace	
	No light	Replace	

STEP TWO	STEP THREE
<p>lift lid, slide up & off screws OR peel off from velcro</p>	<p>Use pen to lift lid, then push and release battery</p>

Replace battery and remount to wall. Dispose of battery responsibly

WARNING! Chemical Burn Hazard. Keep batteries away from children

AVERTISSEMENT! Risque de brûlure chimique: Gardez les piles hors de portée des enfants.

WARNING! The Battery shall be disposed of properly, including keeping them away from children. Even used batteries may cause injury.

AVERTISSEMENT! La batterie doit être mise au rebut de manière appropriée, notamment en la gardant hors de portée des enfants. Même les piles usées peuvent provoquer des blessures.

7.2 User Operating Controls

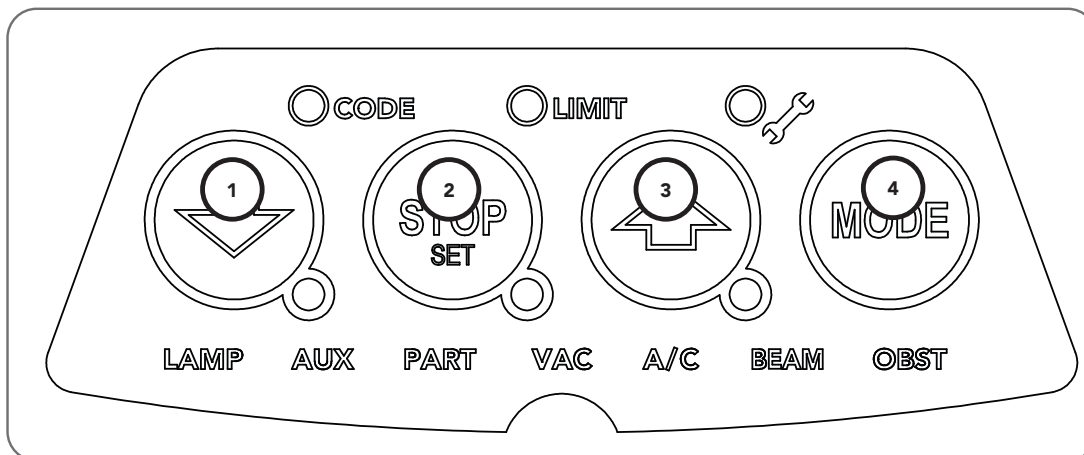

Button	Function
1. BLUE DOWN ARROW	Close Button
2. RED STOP/SET	Stop / Set Button
3. GREEN UP ARROW	Open Button
4. MODE	Mode Selection Button

7.3 Door Status Indicators

Door Status Indicators	OPEN LED (green)	CLOSE LED (blue)	STOP (red)
Open	On		
Close		On	
Opening	Flashing		
Closing		Flashing	
Door travel stopped	Flashing	Flashing	Flashing
Door obstructed when opening	Flashing		On and door will stop
Door obstructed when closing		Flashing	Beeps while door is moving
Opener overloaded	Alternating flashes	Alternating flashes	
Mains power interrupted	Rapid flashes		



HELPFUL TIP: Refer to Appendix C for Additional LED Indicators

7.4 Disposal of Batteries

7.4.1 Correct Disposal of Batteries:

Button Batteries contain toxic materials and should never be disposed of in the trash



WARNING! Button cell lithium batteries MUST have their battery terminals covered BEFORE placing them in the box for shipping. The best way to do this is by taking a strip of tape to make a 'battery ribbon'.

AVERTISSEMENT! Les piles bouton au lithium DOIVENT avoir leurs bornes couvertes AVANT de les placer dans la boîte pour l'expédition. La meilleure façon de procéder est de prendre une bande de ruban adhésif pour créer un 'ruban de batterie'.

Recycling all batteries will have other environmental and social benefits:

- Some batteries are less toxic but hazardous for other reasons. Lithium batteries can explode or catch fire in landfill, while button cells are dangerous if swallowed by children. Recycling offers a safe and environmentally responsible solution for end of life batteries.
- Battery recycling recovers non-renewable materials such as lead, cadmium, stella, zinc, manganese, cobalt, silver, plastics and rare earth elements.
- Removal of batteries and other hazardous household products from household waste facilitates the recovery of organic materials through alternative waste technologies such as composting. Batteries and heavy metals are known contaminants in compost.
- The community supports recycling because it reduces waste to landfill and achieves environmental benefits.



WARNING! The Battery shall be disposed of properly, including keeping them away from children. Even used batteries may cause injury.

AVERTISSEMENT! La batterie doit être mise au rebut de manière appropriée, notamment en la gardant hors de portée des enfants. Même les piles usées peuvent provoquer des blessures.

In the United States of America;

- Call your local solid waste district to find out if your community has a collection program or upcoming event. Or call 1-800-CLEAN-UP (253-2687) or enter a ZIP code at this website to find the nearest recycling center. Information about most recyclable household waste, including household hazardous waste collection centers, is included.
- Search the area for recycling centers that accept single-use batteries using **Earth911.com** Recycling Search. Or call 1-800-CLEAN-UP (1-800-253-2687), a service of Earth 911, to find the nearest recycling center. The website includes information about most recyclable household waste, including household hazardous waste collection centers.
- **CalRecycle E-Waste Disposal Search Directory**. Find an E-waste collector or recycler near you to recycle electronic devices that contain embedded batteries.
- Find **Local Governmental Household Hazardous Waste Agencies**. See the website for local governmental household hazardous waste agencies.

In Canada;

- Find a list of locations on the **Call2Recycle.ca** battery recycling website.
- **Call2Recycle E-Waste Disposal Search Directory**. Find an E-waste collector or recycler near you to recycle electronic devices that contain embedded batteries.
- Find **Local Governmental Household Hazardous Waste Agencies**. See the website for local governmental household hazardous waste agencies.



8. User Maintenance Instruction



WARNING! Run the Safety Testing procedures **MONTHLY** in Section 6.8 to ensure garage door is fit for use.

AVERTISSEMENT! Appliquez les procédures de test de la section 6.8 **UNE FOIS PAR MOIS** pour vous assurer que la porte est en état de marche.

8.1 Door Maintenance

A poorly maintained door could cause fatal / serious injuries or damage to property.

- a. Frequently examine the door, particularly the cables, springs and mountings for signs of wear, damage or imbalance. **DO NOT USE** if repair or adjustment is needed since a fault in the installation or an incorrectly balanced door may cause injury.
- b. Fasteners: Check all screws, nuts and bolts to ensure they are secure.
- c. Spring Tension: It is natural for springs to lose tension. Should the door become hard to operate or completely inoperative, contact a door professional.
- d. Guide Tracks: Clean the internal sections of the guide tracks every 3 - 6 months with a cloth dampened with mineral turps or methylated spirits.

8.2 If You Need a Service Call

If the opener needs a service please call the dealer who installed the garage door opener (their contact details are usually on a sticker on the back of your garage door).

BEFORE CALLING you should have the following information to assist in providing the appropriate service:

1. Has anything happened since the opener last operated OK, e.g. a storm, a jolt to the door etc.?
2. What is the current light status on the opener?
3. Manually disengage the door (Section 5).
How easy is it to manually open and close the door?
4. What model is the opener? (Model no. information is located at the rear of the opener)
5. Who installed the opener? (Dealer details should be on a sticker on the back of your garage door)
6. When was it installed? (If known)



CAUTION: Frequently examine the installation, in particular cables, springs and mountings, for signs of wear, damage or imbalance. **DO NOT USE** if repair or adjustment is needed since a fault in the installation or an incorrectly balanced door may cause injury.

Adjustments should only be carried out by experienced persons, as this function can be dangerous if not performed under strict safety procedures.

ATTENTION: Examinez fréquemment l'installation, en particulier les câbles, les ressorts et les supports, afin de déceler les éventuels signes d'usure, de dommage ou de déséquilibre. **NE PAS utiliser** si la réparation ou un réglage est nécessaire, car un défaut dans l'installation ou une porte mal équilibrée peut causer des blessures.

Les réglages ajustements ne doivent être effectués que par des techniciens expérimentés, car cette fonction peut être dangereuse si elle n'est pas effectuée dans le strict respect des procédures de sécurité.



WARNING! Failure to maintain your garage door may void the warranty on your garage door operator.

AVERTISSEMENT! L'absence d'entretien votre porte de garage peut annuler la garantie de votre dispositif d'ouverture.



9. Troubleshooting

Symptom	Possible cause	Remedy
The opener does not work from the Remote Control Transmitter	<p>Garage door in poor condition e.g. springs may be broken</p> <p>The opener does not have power</p> <p>The battery in the Remote Control is flat</p> <p>The opener has been put into "Vacation Mode"</p> <p>The Remote Control button is not programmed to operate the door.</p> <p>Door Code LED is flashing yet the opener is not working.</p>	<p>Check the door's operation - see monthly maintenance (Section 8)</p> <p>Plug a device of similar voltage (e.g. a hairdryer) into the power point and check that it is OK</p> <p>Replace the battery (Section 7.1.2)</p> <p>Turn off "Vacation Mode" (Appendix E, Vacation Mode step E.5)</p> <p>See coding transmitter procedure (Section 6.7)</p> <p>Ensure the correct button on the transmitter is being pressed.</p>
The motor is running but the door remains stationary	The opener is disengaged	Re-engage the opener (Section 5)
The transmitter range varies or is restricted	<p>Variations are normal depending on conditions e.g. temperature or external interference</p> <p>The battery life is exhausted</p> <p>Position of the Remote Control Transmitter in the motor vehicle</p>	<p>See instructions for correct use of transmitter (Section 7.1.1)</p> <p>Refer to battery status (Section 7.1.2)</p> <p>Change the position (Section 7.1)</p>
The door reverses for no apparent reason	<p>This may occur occasionally from environmental conditions such as areas that are windy, dusty or have extreme temperature changes.</p> <p>If Safety Beams are installed they may be partially obstructed.</p>	<p>Put the door into manual (Section 5, take note of the CAUTION) and contact (800) 934 9892.</p> <p>Ensure the beam path is not obstructed. If continues, contact your optional extras dealer.</p>
The door opens but will not close	Safety Beam (Optional Accessory) not operating correctly	Contact your optional extras dealer for support.
The Open (Green) LED and Close (Blue) LED are flashing alternatively	Opener is overloaded	Discontinue use and contact (800) 934 9892 for support.
The Open (Green) LED continues to flash	Door obstructed when opening	Clear away any obstructions and test door opens correctly. (If door is damaged, contact a door professional).
The Close (Blue) LED continues to flash	<p>Door obstructed when closing</p> <p>Limits may be cleared</p>	<p>Clear away any obstructions and test door closes correctly. (If door is damaged, contact your dealer).</p> <p>Remove all power sources. Wait till all lights are out (10-15 secs), then reconnect power. If Blue LED is flashing, limits are not set.</p> <p>See Section 6 to set LIMITS.</p>



10. Appendix

A - Adjustment Mode Parameters

STEP ONE

Remove controls cover

Press repeatedly → till Spanner LED is lit → One of the word LED's will light up

LAMP AUX PART VAC A/C BEAM OBST

STEP TWO

Press to move to particular parameter LED OR → Press to enter parameter

STEP THREE

will flash to indicate parameter value in table below

STEP FOUR

Use either button to scroll through OR

If no beep is heard, max or min setting is reached.

LED Indicators	Parameter	OPEN	OPEN & STOP	STOP	CLOSE & STOP	CLOSE
LAMP LED	Light Time	180s	120s	60s	30s	0s
AUX LED	Aux Time / Mode	Toggle	60s	30s	1s	Mimic Light
A/C LED	A/C Function	90s	60s	30s	15s	OFF
A/C & BEAM LED'S	PE A/C Function	60s	30s	15s	5s	OFF
OBST LED	Margin Setting	20 units	15 units	12 units	9 units	7 units
OPEN / STOP / CLOSE LED'S	PG3 custom setting	When all three lights are illuminated a custom setting is in place. Parameters can be still adjusted to those listed above.				

STEP FIVE

Press to save OR Press to leave unchanged → Operating MODE is entered after 5 secs, unless a new adjustment is started or saved.

Press to exit

Auxiliary Output

The auxiliary output can be used to control alarm or another garage door opener. A valid transmission from the pre-coded transmitter will cause the auxiliary output to pulse for approximately 1 (one) second. The maximum DC voltage must not exceed 35 volts DC. Maximum current must not exceed 80 ma.

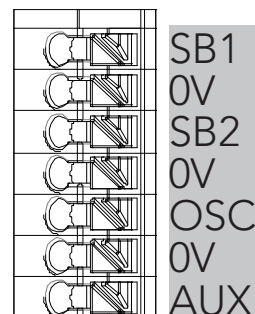

B - Setting the PET Mode position

STEP ONE

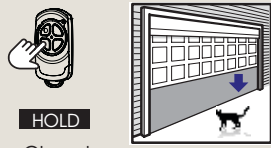

HOLD
Close to desired position

STEP TWO

Remove controls cover



MODE → **LIMIT**

Press repeatedly till LIMIT LED is lit

STEP FOUR



PART

Press repeatedly till PART LED lit

STEP FIVE



STOP SET **HOLD for 2 secs**

Release

Proceed to Appendix E to code a remote button to PART Mode



When activated, PET mode drives the door to a preset position from the close position, therefore allowing a pet or parcel to go under the door.

C - LED Status

The below table displays the status of the opener when LEDs are activated.

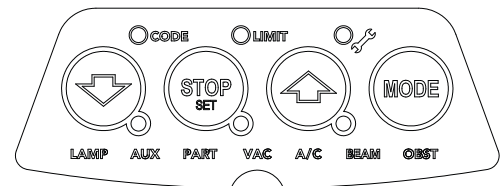

LED Indicators		Status
CODE LED		Flickers with transmitter activity or indicating transmitter may not be coded to the opener.
LIMIT LED		Indicates the opener is in Limit Set Mode
SPANNER LED		Indicates the opener is in Adjustment Mode
CLOSE / STOP / OPEN LED'S		Indicate the shutter status currently in use (except during power failure, auto-close and part open)
LAMP LED		Only illuminates during the Adjustment Mode to change the light time parameter
AUX LED		Indicates the AUX output is activated, once a transmitter has been coded to the AUX function.
PART LED		Indicates the shutter is in one of the part open positions.
VAC LED		Indicates the Vacation Mode is active
A/C LED	On STEADY	means the auto-close timer was paused due to the beam being blocked.
	FLASHES	to indicate the auto-close timer is running
BEAM LED	On STEADY	when a beam is blocked.
	FLASHES	when there is a PE Fault
OBST LED	On STEADY	Obstruction was detected. If shutter open then obstruction was while closing and vice versa
	FLASHES	Stall / Overload detected. If shutter open then stall / overload while closing and vice versa.
SPANNER LED	On STEADY	Indicates the service is due. Beeps three times at start of a drive cycle
	MAIN LIGHT FLASHES	Two flashes indicates that the battery is faulty. Five Flashes indicates that periodic maintenance is due after 3000 drive cycles.
	FLASHES	Indicates a fault. The details is indicated on the other LEDs.
	+ OBST LED	Indicates current sensor fault
	+ OPEN LED	Indicates failed to profile open travel - during limit setting only
	+ CLOSE LED	indicated failed to profile close travel - during limit setting only

D - Setting Limits via Transmitter

The Dominator Hiro has the ability to set travel limits using a transmitter, allowing free movement around the garage to better assess the desired limit positions. In order to use a transmitter, it must first have at least one of its buttons coded to the shutter controller. The function assigned to the transmitter's buttons is of no concern here as the buttons are temporarily assigned to OPEN, SET, CHANGE DIRECTION and CLOSE (Fig. D.1).

D.1 code a transmitter for limit setting

tip The SPEED setting on the opener CAN NOT be adjusted when setting limits via the transmitter. Follow section 12.1 to set limits and adjust speed.

STEP ONE	STEP TWO
 →  Switch power on. BLUE LED will flash	 →  Press repeatedly till CODE LED is lit
STEP THREE	
 OR  →	   till all three LED's are lit
STEP FOUR	STEP FIVE
 →  HOLD to enter coding	 → To exit coding Then replace controls cover
HOLD for 3 sec RELEASE HOLD for 3 sec Release both buttons	

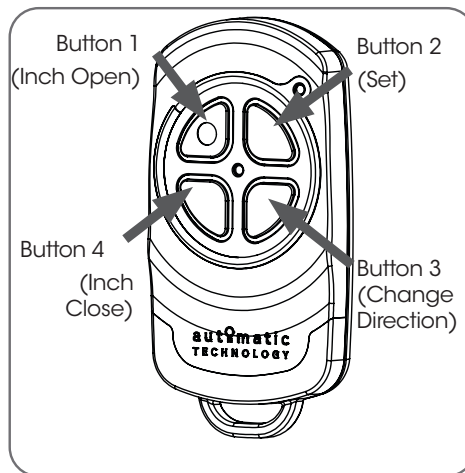

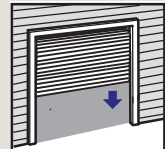





Fig: D.1

CLOSE LIMIT POSITION	
STEP ONE	STEP TWO
 →  HOLD to Close	 When door near close, single presses inch door
Button 4 is factory coded to CLOSE function.	CLOSE limit should be when rubber strip touches the ground



OPEN LIMIT POSITION	
STEP ONE	STEP TWO
 →  HOLD to Open	 When door near open, single presses inch door
Button 1 is factory coded to OPEN function.	OPEN limit should be the height of the garage opening

WARNING! In setting the close limit position, do not force the door into the floor with excessive force, as this can interfere with the ease of operation of the manual release mechanism.

AVERTISSEMENT! Ne pas forcer la porte contre le sol lors du réglage de fin de course, car une force excessive peut entraver le fonctionnement du système de déclenchement manuel.

WARNING! The door will automatically close, open and close again after the next step. Ensure that nothing is in the door's path.







AVERTISSEMENT! La porte va se fermer puis s'ouvrir automatiquement, avant de se fermer. S'assurer que rien ne bloque l'ouverture ou la fermeture de la porte.

STEP THREE	
If door overshoots  →  →  Press to Open Press to Close position	Press to set Button 2 is factory coded to SET function



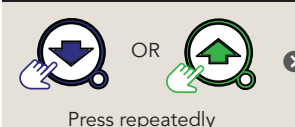

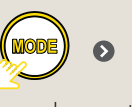

STEP THREE	
If door overshoots  →  →  Press to Close Press to Open position	Press to set

E - Additional Remote Control Functions



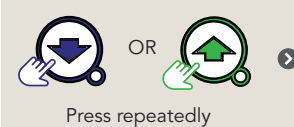

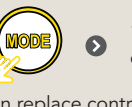

E.1 remote control button to the courtesy light

STEP ONE		STEP TWO	
 remove controls cover		 Press repeatedly till CODE LED is lit	
STEP THREE			
 Press repeatedly		LAMP till LAMP LED lit	
STEP FOUR		STEP FIVE	
 HOLD to enter coding	 HOLD for 3 sec RELEASE HOLD for 3 sec Release both buttons	 To exit coding Then replace controls cover	
STEP SIX			
 Press to test			



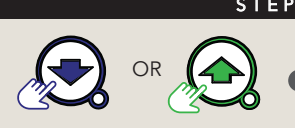





E.3 remote control button to operate PART Mode

STEP ONE		STEP TWO	
 remove controls cover		 Press repeatedly till CODE LED is lit	
STEP THREE			
 Press repeatedly		PART till PART LED lit	
STEP FOUR		STEP FIVE	
 HOLD to enter coding	 HOLD for 3 sec RELEASE HOLD for 3 sec Release both buttons	 To exit coding Then replace controls cover	
STEP SIX			
 Press to test			

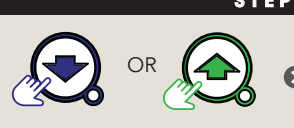
E.2 remote control button to enable AUX output

STEP ONE		STEP TWO	
 remove controls cover		 Press repeatedly till CODE LED is lit	
STEP THREE			
 Press repeatedly		AUX till AUX LED lit	
STEP FOUR		STEP FIVE	
 HOLD to enter coding	 HOLD for 3 sec RELEASE HOLD for 3 sec Release both buttons	 To exit coding Then replace controls cover	
STEP SIX			
 Press to test			

E.4 remote control button to activate vacation mode

STEP ONE		STEP TWO	
 remove controls cover		 Press repeatedly till CODE LED is lit	
STEP THREE			
 Press repeatedly		VAC till VAC LED lit	
STEP FOUR		STEP FIVE	
 HOLD to enter coding	 HOLD for 3 sec RELEASE HOLD for 3 sec Release both buttons	 To exit coding Then replace controls cover	
STEP SIX			
 HOLD for 4 sec RELEASE Turn on		 Turn off Press, then try another remote	